

# AquaBlox™ Water Matrix®

- Large dimension 26.97" x 16.06" x 17.72" - 32 Gallon Volume - Weight 15.4 lbs - 38 PSI Load Bearing Weight
- Small dimension 26.97" x 16.06" x 9.45" - 17 Gallon Volume - Weight 10.35 lbs - 38 PSI Load Bearing Weight
- Surface Area - 95% void
- Material - 85% recycled Polypropylene + 15% propriety selected materials
- Biological & Chemical Resistance - Unaffected by molds, algae, soil-bourne chemicals, and bacteria

## Small AquaBlox™ Water Matrix®

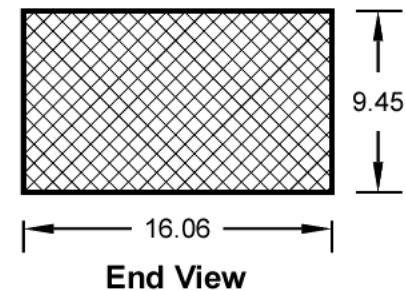
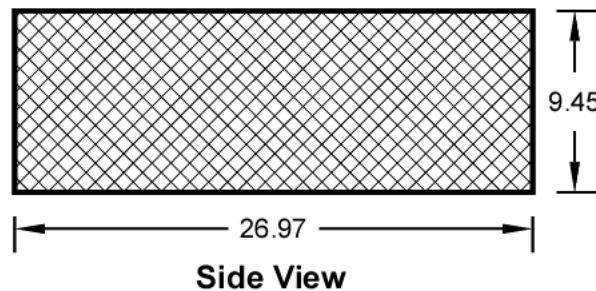
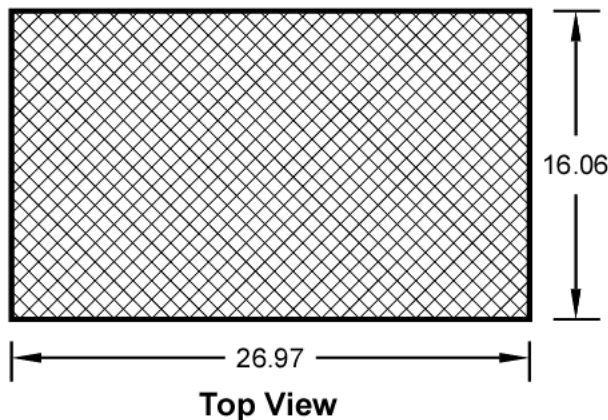

## Large AquaBlox™ Water Matrix®

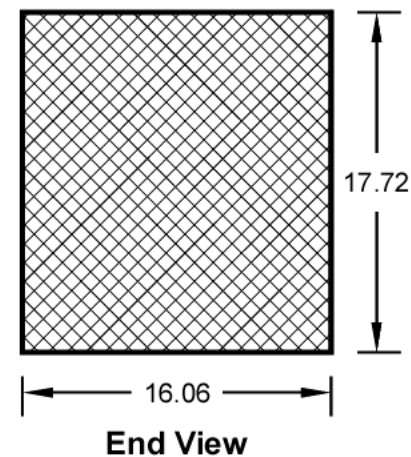
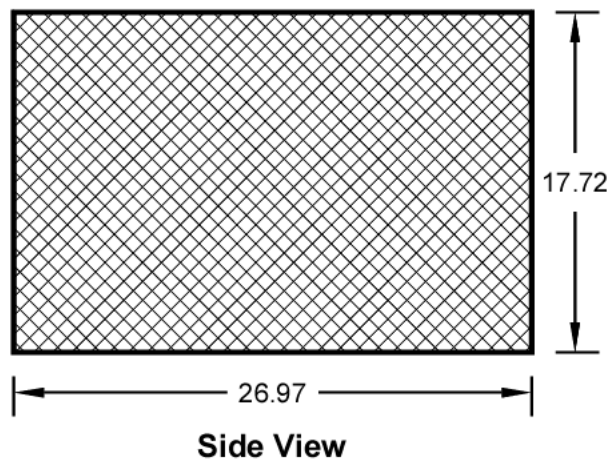
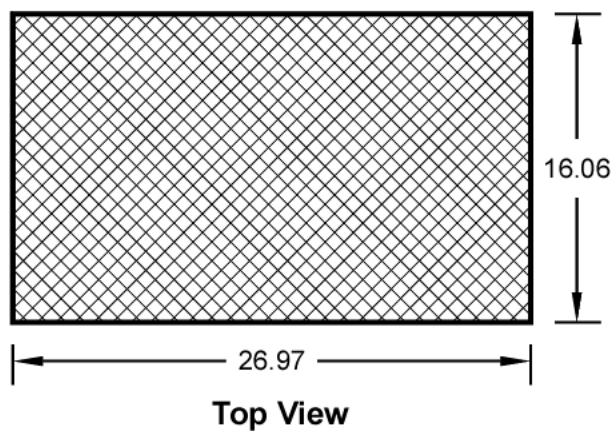

**End View**

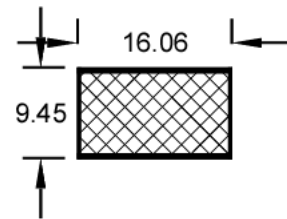
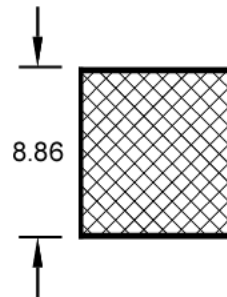
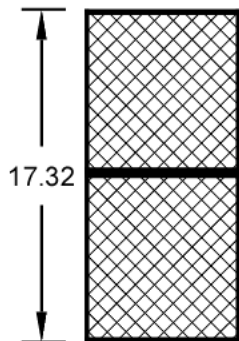
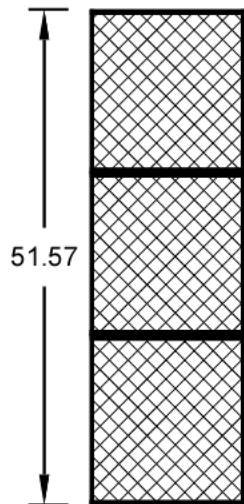
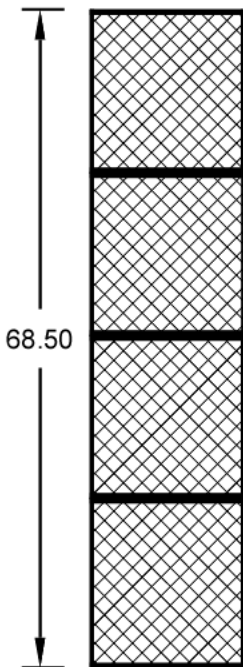
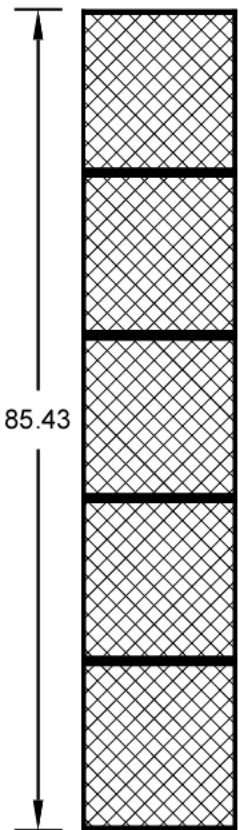

**Side View**

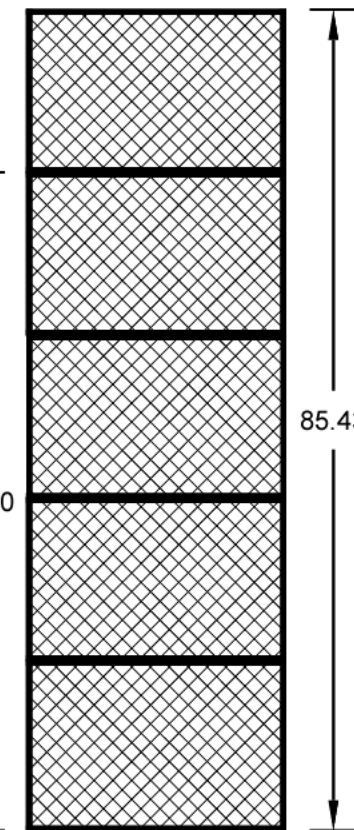
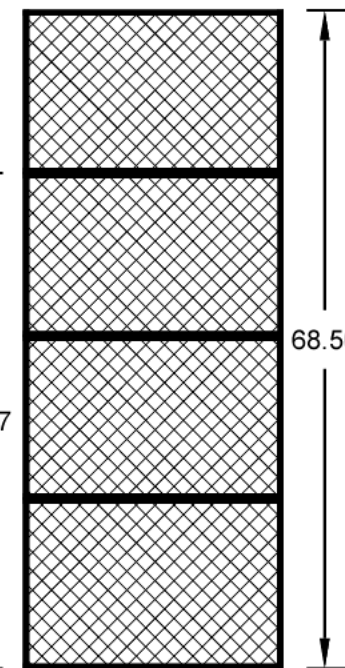
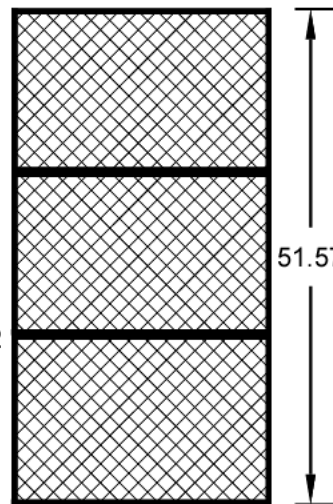
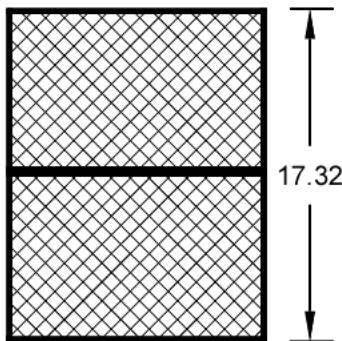
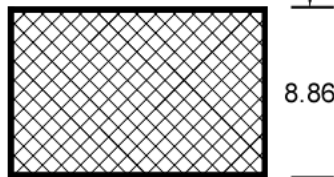

**Mini**

**Single**

**Double**

**Triple**

**Quad**

**Penta**